

d line
KNUD HOLSCHER DESIGN

www.dline.com



Hardware

Hardware
Bathroom
Washroom
Handrail
Wardrobe
Signs



Uniform Aestheticism

The **d line** Total Solution is a comprehensive package of timelessly elegant hardware comprising door handles, bathroom fittings, washroom panels, handrail, wardrobe components and signs. By offering such a diversity of hardware products unified by a single design concept, a concept visible in every item and detail, **d line** aims to support the architect in the quest for a homogenous visual expression relating the parts and detail of an environment to the architectural whole.

In the words of **d line** designer, architect Knud Holscher:

"Very simple ironmongery is to architecture what buttons are to a shirt; both should support the design and not detract from the overall expression."

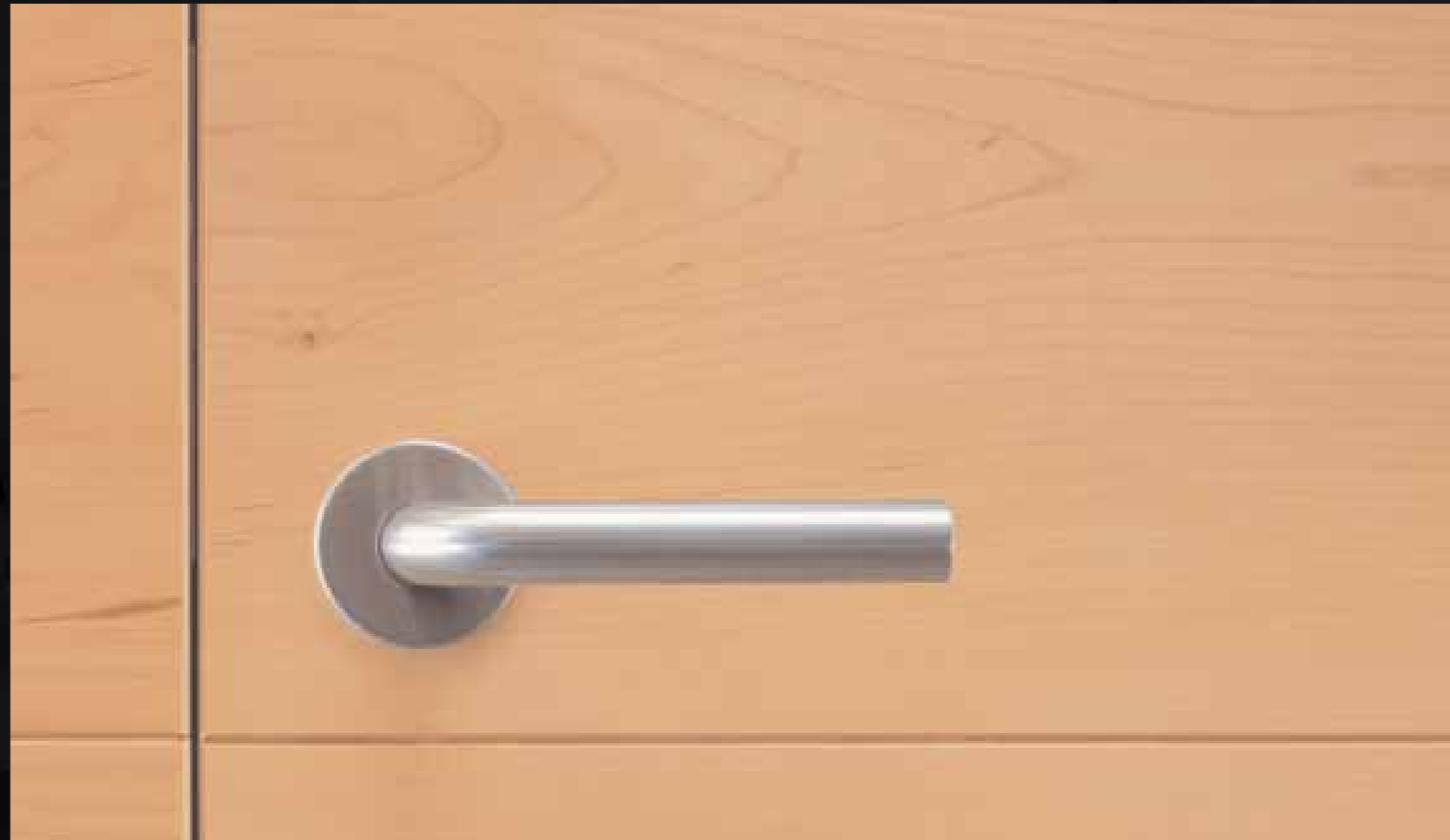

Solid Simplicity

The overriding characteristics of **d line** are solidity and simplicity. Throughout thirty years of continuous product development **d line** has acquired a detailed knowledge of AISI 316 stainless steel. In many ways **d line** products continue to benefit from the remarkable properties of this material: strength, longevity, and high corrosion resistance; all of which are substantiated through rigorous testing at certified institutes

The enduring nature of **d line** is also evidenced in its visual qualities.

Knud Holscher: *"Where can a thing of beauty, once exercised, exude a greater effect?"*

d line durability remains unaltered even after years of use, the material is improved as a result of patination, a process that inevitably provides character. This result cannot be attained with cheaper solutions where ageing is synonymous with decay."





The Material

All **d line** products are manufactured in grade AISI 316, a particularly robust type of non-corrosive stainless steel. This not only ensures great finish stability and strength, but also ensures an elegant and easily maintained appearance. Even in high humidity environments or climatically challenging areas, the high-quality finish of **d line** ironmongery endures with a minimum of effort.





d line Experience

d line understands the conflicts of accessibility and security from a unique perspective. The strict application of form and function, in the simplest terms, helps to prevent design ingenuity from slighting concerns vital to a fittings application. In order to remain the market leader, Knud Holscher and **d line** rely on site experience and technical advancement. Through their involvement in numerous international projects, **d line** has a constant dialogue with architects, engineers and specifiers from all corners of the world, from which new ideas flow and add to **d line** product development.



Technical Refinement



2

d line door handles incorporate a concealed fixing mechanism using sectional countersunk bolts. Levers operate effortlessly due to the unique **d line** bearing assembly. These and other features, specially developed by **d line** have been integrated in the design in order to optimise reliability and endurance. A heavy duty classification under EN1906 is evidence to the fact that **d line** levers operate smoothly, even when used aggressively over time.



1



3



5



7



8



9



10

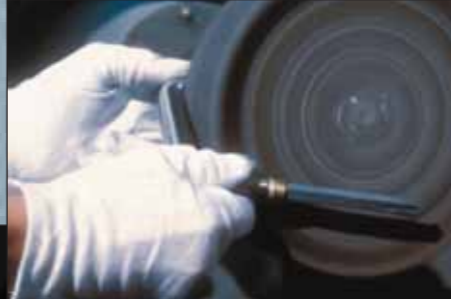

6



11



4

1	Tube lever with solid inserts		
2	Precision joints		
3	Torx screw driver		14.9767.00.105
4	Wide range of spindles		
5	Neck screw attachment		14.9701.02.016
6	Craftmanship grinding		
7	Steel door bush (Pat. Pend.)	<60mm	14.2988.00.005
		>60mm	14.2988.00.609
8	Release tool for snap-on covers		14.2935.00.089
9	Door preparation tool, ex Scandinavia		14.2928.00.003
10	Door preparation tool, Scandinavia	A 7-20mm	14.2925.00.007
		A 20-40mm	14.2925.00.204
11	Bolt and screw mounting of rose		
12	Back-to-back concealed through fixing	75mm	14.2961.74.077
		100mm	14.2961.74.107



12

Consistency and Continuity

In accordance with the tradition of structural simplicity inherent in Danish design, **d line** works within the confines of minimalist aesthetics: few geometric principles, clean, sturdy appearance and functionality. In part, these qualities spring from Knud Holscher's emphasis on the self-explanatory status of a fitting:

"The end user must be able to decipher the product's function immediately. Resulting from this rule is a kind of 'evident' simplicity which leaves the creative initiative with the architect responsible for the overall scheme."

d line's architectural approach to hardware design ensures that every single fitting has been developed in relation to an overall design concept. Herein lies a variety of practical advantages: regardless of which type of hinge, handle, or locking mechanism the architect chooses for his project, the result will be one of consistency and continuity.

Lever U2 Shape



Lever U Shape



Lever L Shape



Lever M Shape



Lever UF Shape



Lever FF Shape



Lever B Shape



Lever C2 Shape



Lever C Shape



Lever Accessories



Knob CK Shape



Knob KK Shape



Knob FK Shape



Heavy Straight Pulls



Circular Pulls



Cranked Pulls



Straight Pulls



Pulls and Flush Pulls, Miscellaneous



Door Stops



Cabinet Handles



Cabinet Knobs and Furniture Pulls



Window Levers



Sign Selection



Indicators Hinges Bell Pushes



Cylinders



Lock Cases



Panic Exit Devices



Door Closers





Lever L Shape



A d line front runner since the early seventies, the L shape is not only the classic model of the series, but also the lever enjoying the widest application. With this lever, the d line tradition of stalwart, minimalist design was established. The integration of form and function is so smooth that the lever's contemporary status remains undiminished.



Standard Specification:
 Door thickness 33-59mm
 Door thickness, bathroom 34-48mm
 Conform to EN1906
 For different door thicknesses please specify



16mm levers, complete	AA		L160001	L160001H	L160201	L160301	L160501	L160501	L160101		
19mm levers, complete	AA		L190001	L190001H	L190201	L190301	L190501	L190501	L190101		
19mm levers for fire doors, complete	AA		L390001	L390001H	L390201	L390301	L390501	L390501	L390101		
16mm levers, complete	BB		L160003	L160003H	L160204	L160304	L160504	L160504	L160103		
19mm levers, complete	BB	ⓘ	L190003	L190003H	L190204	L190304	L190504	L190504	L190103		
19mm levers for fire doors, complete	BB		L390003	L390003H	L390204	L390304	L390504	L390504	L390103		
16mm levers, complete	PZ		L160007	L160007H	L160208	L160308	L160508	L160508	L160107	L160908	L161109
19mm levers, complete	PZ	ⓘ	L190007	L190007H	L190208	L190308	L190508	L190508	L190107	L190908	L191109
19mm levers for fire doors, complete	PZ		L390007	L390007H	L390208	L390308	L390508	L390508	L390107	L390908	L391109
16mm levers, complete	BL		L160024	L160024H					L160124		
19mm levers, complete	BL	●	L190024	L190024H					L190124		
19mm levers for fire doors, complete	BL		L390024	L390024H					L390124		
16mm levers, complete	WC	☺ ☹	L160026		L160229	L160329	L160529	L160629			
19mm levers, complete	WC		L190026		L190229	L190329	L190529	L190629			
16mm levers, complete	WC disabled	☺ ☹	L160032								
19mm levers, complete	WC disabled	☺ ☹	L190032								

Set with fixed exterior knob	PZ	ⓘ	LCK190010		LCK190211	LCK190311	LCK190511	LCK190611		
	PZ		LKK190010		LKK190211	LKK190311	LKK190511	LKK190611		
	PZ		LFK190010		LFK190211	LFK190311	LFK190511	LFK190611		

L CK KK FK

Lever U Shape

A product of simple geometry the U lever constitutes a classic at **d line**. Its extensive surface and return to door geometry - features ensuring an easy and firm hold - have made the U lever a popular choice for day-care centres, hospitals, as well as other buildings occupied by children, senior citizens, or the less able.

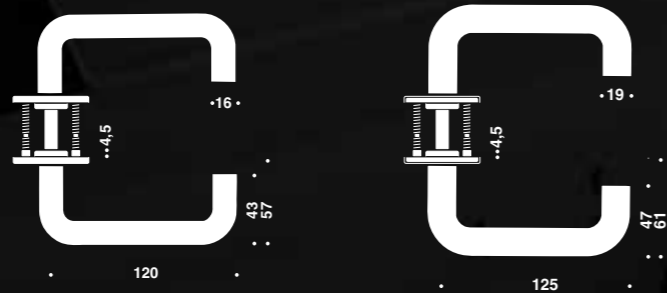

Dummy Lever Handle

-  DL1911501
-  DL1911503
-  DL1911507
-  DL1911509

Standard Specification:
 Door thickness 33-59mm
 Door thickness, bathroom 34-48mm
 Conform to EN1906/EN179
 For different door thicknesses please specify

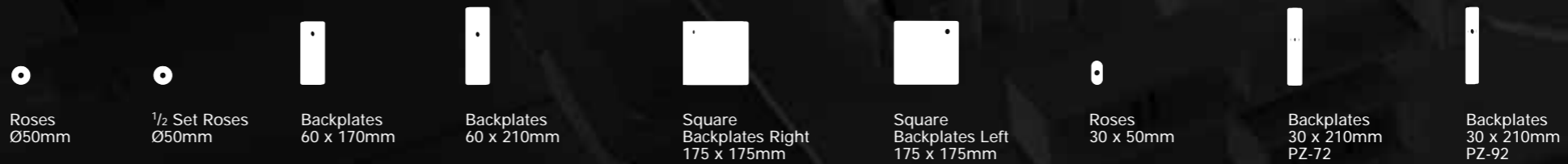

16mm levers, complete	AA	U160001	U160001H	U160201	U160301	U160501	U160501	U160101		
19mm levers, complete	AA	U190001	U190001H	U190201	U190301	U190501	U190501	U190101		
19mm levers for fire doors, complete	AA	U390001	U390001H	U390201	U390301	U390501	U390501	U390101		
16mm levers, complete	BB	U160003	U160003H	U160204	U160304	U160504	U160504	U160103		
19mm levers, complete	BB	U190003	U190003H	U190204	U190304	U190504	U190504	U190103		
19mm levers for fire doors, complete	BB	U390003	U390003H	U390204	U390304	U390504	U390504	U390103		
16mm levers, complete	PZ	U160007	U160007H	U160208	U160308	U160508	U160508	U160107	U160908	U161109
19mm levers, complete	PZ	U190007	U190007H	U190208	U190308	U190508	U190508	U190107	U190908	U191109
19mm levers for fire doors, complete	PZ	U390007	U390007H	U390208	U390308	U390508	U390508	U390107	U390908	U391109
16mm levers, complete	BL	U160024	U160024H					U160124		
19mm levers, complete	BL	U190024	U190024H					U190124		
19mm levers for fire doors, complete	BL	U390024	U390024H					U390124		
16mm levers, complete	WC	U160026		U160229	U160329	U160529	U160629			
19mm levers, complete	WC	U190026		U190229	U190329	U190529	U190629			
16mm levers, complete	WC disabled	U160032								
19mm levers, complete	WC disabled	U190032								

Set with fixed exterior knob
 U CK KK FK

PZ
 PZ
 PZ

UCK190010
 UKK190010
 UFK190010

UCK190211
 UKK190211
 UFK190211

UCK190311
 UKK190311
 UFK190311

UCK190511
 UKK190511
 UFK190511

UCK190611
 UKK190611
 UFK190611







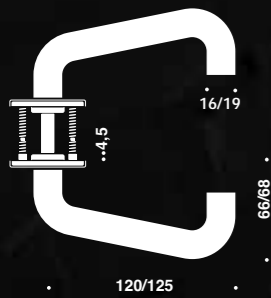



Lever U2 Shape

The handle's lateral beam no longer runs parallel to the door, but is instead angled out toward the user, allowing the fingers to grasp an ergonomically correct diagonal line. As an extra subtlety, the alteration in relation to the original U handle is only noticeable when seen from above.



Standard Specification:
 Door thickness 33-44mm
 Door thickness, bathroom 34-44mm
 Conform to EN1906/EN 179
 For different door thicknesses please specify

											
			Roses Ø50mm	1/2 Set Roses Ø50mm	Backplates 60 x 170mm	Backplates 60 x 210mm	Square Backplates Right 175 x 175mm	Square Backplates Left 175 x 175mm	Roses 30 x 50mm	Backplates 30 x 210mm PZ-72	Backplates 30 x 210mm PZ-92
16mm levers, complete	AA		U2160001	U2160001H	U2160201	U2160301	U2160501	U2160501		U2160101	
19mm levers, complete	AA		U2190001	U2190001H	U2190201	U2190301	U2190501	U2190501		U2190101	
19mm levers for fire doors, complete	AA		U2390001	U2390001H	U2390201	U2390301	U2390501	U2390501		U2390101	
16mm levers, complete	BB		U2160003	U2160003H	U2160204	U2160304	U2160504	U2160504		U2160103	
19mm levers, complete	BB	🔒	U2190003	U2190003H	U2190204	U2190304	U2190504	U2190504		U2190103	
19mm levers for fire doors, complete	BB		U2390003	U2390003H	U2390204	U2390304	U2390504	U2390504		U2390103	
16mm levers, complete	PZ		U2160007	U2160007H	U2160208	U2160308	U2160508	U2160508		U2160107	U2160908
19mm levers, complete	PZ	🔒	U2190007	U2190007H	U2190208	U2190308	U2190508	U2190508		U2190107	U2190908
19mm levers for fire doors, complete	PZ		U2390007	U2390007H	U2390208	U2390308	U2390508	U2390508		U2390107	U2390908
16mm levers, complete	BL		U2160024	U2160024H						U2160124	
19mm levers, complete	BL	🔒	U2190024	U2190024H						U2190124	
19mm levers for fire doors, complete	BL		U2390024	U2390024H						U2390124	
16mm levers, complete	WC	🚻	U2160026		U2160229	U2160329	U2160529	U2160629			
19mm levers, complete	WC	🚻	U2190026		U2190229	U2190329	U2190529	U2190629			
16 mm levers, complete	WC disabled	🚻	U2160032								
19 mm levers, complete	WC disabled	🚻	U2190032								
Set with fixed exterior knob	PZ	🔒	U2CK190010		U2CK190211	U2CK190311	U2CK190511	U2CK190611			
	PZ		U2KK190010		U2KK190211	U2KK190311	U2KK190511	U2KK190611			
	PZ		U2FK190010		U2FK190211	U2FK190311	U2FK190511	U2FK190611			

LF CK KK FK

Lever UF Shape

Lever UF shape is a variation on the design expression seen in the **d line** L and U designs. The continuity of the formal and visual qualities is retained despite a new set of characteristics, one of which being the additional bend. Hereby, the distance between hand/lever and door frame is increased, enhancing the safety aspect, yet ensuring a sympathetic solution.



Standard Specification:
 Door thickness 33-44mm
 Door thickness, bathroom 34-44mm
 Conform to EN1906/EN179
 For different door thicknesses please specify

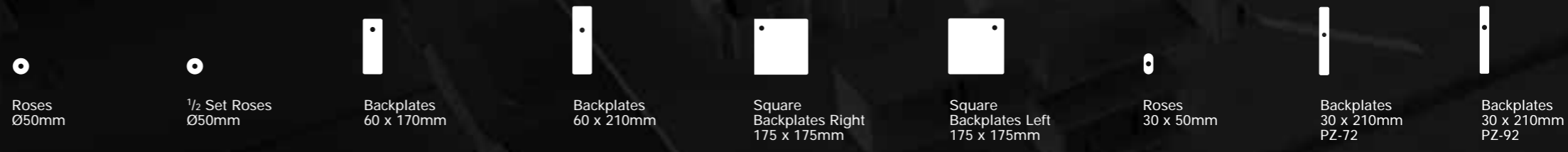

19mm levers, complete	AA		UF190001	UF190001H	UF190201	UF190301	UF190501	UF190501	UF190101		
19mm levers for fire doors, complete	AA		UF390001	UF390001H	UF390201	UF390301	UF390501	UF390501	UF390101		
19mm levers, complete	BB	●	UF190003	UF190003H	UF190204	UF190304	UF190504	UF190504	UF190103		
19mm levers for fire doors, complete	BB		UF390003	UF390003H	UF390204	UF390304	UF390504	UF390504	UF390103		
19mm levers, complete	PZ	●	UF190007	UF190007H	UF190208	UF190308	UF190508	UF190508	UF190107	UF190908	UF191109
19mm levers for fire doors, complete	PZ		UF390007	UF390007H	UF390208	UF390308	UF390508	UF390508	UF390107	UF390908	UF391109
19mm levers, complete	BL	●	UF190024	UF190024H					UF190124		
19mm levers for fire doors, complete	BL		UF390024	UF390024H					UF390124		
19mm levers, complete	WC	☺	UF190026		UF190229	UF190329	UF190529	UF190629			
19mm levers, complete	WC disabled	☺	UF190032								
Set with fixed exterior knob	PZ	●	UFCK190010		UFCK190211	UFCK190311	UFCK190511	UFCK190611			
	PZ		UFKK190010		UFKK190211	UFKK190311	UFKK190511	UFKK190611			
	PZ		UFFK190010		UFFK190211	UFFK190311	UFFK190511	UFFK190611			







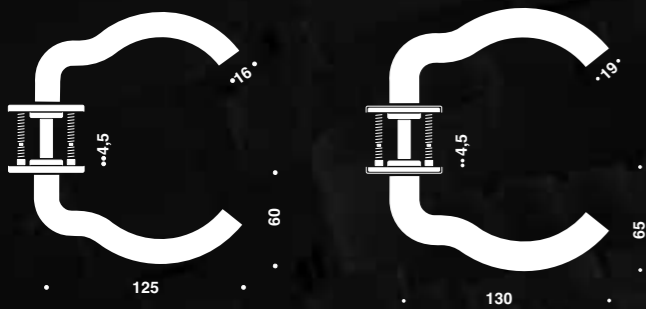









Lever M Shape

The M lever is the d line expression of a restrained design concept allowing for the inclusion of organic elements. The main characteristics of the d line M shape are two intersecting circles that create the beautifully curved lines of the lever. Though this distinguishing feature may seem to be in contrast to the classic d line models, it preserves the minimalistic ethos of the series and accommodates the hand like its predecessors.



Standard Specification:
 Door thickness 33-44mm
 Door thickness, bathroom 34-44mm
 Conform to EN1906
 For different door thicknesses please specify

											
			Roses Ø50mm	1/2 Set Roses Ø50mm	Backplates 60 x 170mm	Backplates 60 x 210mm	Square Backplates Right 175 x 175mm	Square Backplates Left 175 x 175mm	Roses 30 x 50mm	Backplates 30 x 210mm PZ-72	Backplates 30 x 210mm PZ-92
16mm levers, complete	AA		M160001	M160001H	M160201	M160301	M160501	M160501	M160101		
19mm levers, complete	AA		M190001	M190001H	M190201	M190301	M190501	M190501	M190101		
16mm levers, complete	BB		M160003	M160003H	M160204	M160304	M160504	M160504	M160103		
19mm levers, complete	BB		M190003	M190003H	M190204	M190304	M190504	M190504	M190103		
16mm levers, complete	PZ		M160007	M160007H	M160208	M160308	M160508	M160508	M160107	M160908	M161109
19mm levers, complete	PZ		M190007	M190007H	M190208	M190308	M190508	M190508	M190107	M190908	M191109
16mm levers, complete	BL		M160024	M160024H					M390107		
19mm levers, complete	BL		M190024	M190024H					M160124		
16mm levers, complete	WC		M160026		M160229	M160329	M160529	M160629			
19mm levers, complete	WC		M190026		M190229	M190329	M190529	M190629			
16mm levers, complete	WC disabled		M160032								
19mm levers, complete	WC disabled		M190032								
Set with fixed exterior knob	PZ		MCK190010		MCK190211	MCK190311	MCK190511	MCK190611			
	PZ		MKK190010		MKK190211	MKK190311	MKK190511	MKK190611			
	PZ		MFK190010		MFK190211	MFK190311	MFK190511	MFK190611			

M CK KK FK

Lever C Shape

Like the M shape, the C shaped lever is an instance of innovation within the framework of an existing design concept. Here, the challenge faced by Knud Holscher and **d line** lay in the formation of a distinctly modern lever drawing on the widely used Scandinavian 'coupe' design. Benefiting from improved techniques of metal bending in the nineties, it proved feasible for Knud Holscher to experiment with another kind of geometric simplicity. The result of this working process is the C lever.



Standard Specification:
 Door thickness 33-59mm
 Door thickness, bathroom 34-48mm
 Conform to EN1906/EN179
 For different door thicknesses please specify

Roses Ø50mm	1/2 Set Roses Ø50mm	Backplates 60 x 170mm	Backplates 60 x 210mm	Square Backplates Right 175 x 175mm	Square Backplates Left 175 x 175mm	Roses 30 x 50mm	Backplates 30 x 210mm PZ-72	Backplates 30 x 210mm PZ-92

16mm levers, complete	AA	C160001	C160001H	C160201	C160301	C160501	C160501	C160101		
19mm levers, complete	AA	C190001	C190001H	C190201	C190301	C190501	C190501	C190101		
19mm levers for fire doors, complete	AA	C390001	C390001H	C390201	C390301	C390501	C390501	C390101		
16mm levers, complete	BB	C160003	C160003H	C160204	C160304	C160504	C160504	C160103		
19mm levers, complete	BB	C190003	C190003H	C190204	C190304	C190504	C190504	C190103		
19mm levers for fire doors, complete	BB	C390003	C390003H	C390204	C390304	C390504	C390504	C390103		
16mm levers, complete	PZ	C160007	C160007H	C160208	C160308	C160508	C160508	C160107	C160908	C161109
19mm levers, complete	PZ	C190007	C190007H	C190208	C190308	C190508	C190508	C190107	C190908	C191109
19mm levers for fire doors, complete	PZ	C390007	C390007H	C390208	C390308	C390508	C390508	C390107	C390908	C391109
16mm levers, complete	BL	C160024	C160024H					C160124		
19mm levers, complete	BL	C190024	C190024H					C190124		
19mm levers for fire doors, complete	BL	C390024	C390024H					C390124		
16mm levers, complete	WC	C160026		C160229	C160329	C160529	C160629			
19mm levers, complete	WC	C190026		C190229	C190329	C190529	C190629			
16mm levers, complete	WC disabled	C160032								
19mm levers, complete	WC disabled	C190032								

Set with fixed exterior knob
 C + CK KK FK

PZ
 PZ
 PZ

CCK190010
 CKK190010
 CFK190010

CCK190211
 CKK190211
 CFK190211

CCK190311
 CKK190311
 CFK190311

CCK190511
 CKK190511
 CFK190511

CCK190611
 CKK190611
 CFK190611







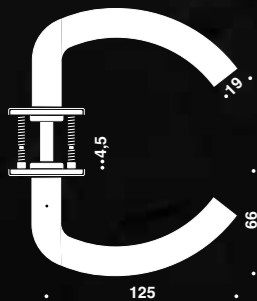









Lever C2 Shape



The point of departure for this brand new fixture is d line's original C handle; modified with a 33.3 degree upward tilt. Seen from the front, the new handle presents the viewer with an arched appearance. The handle may be mounted upside down allowing for several creative installation possibilities. By inverting this fixture, the space where the hand is placed in order to operate the handle becomes emphasized. In this arched edition, the C handle is even more user-friendly than its predecessor.



Standard Specification:
 Door thickness 33-44mm
 Door thickness, bathroom 34-44mm
 Conform to EN1906/EN179
 For different door thicknesses please specify

												
			Roses Ø50mm	1/2 Set Roses Right Ø50mm	1/2 Set Roses Left Ø50mm	Backplates 60 x 170mm	Backplates 60 x 210mm	Square Backplates Right 175 x 175mm	Square Backplates Left 175 x 175mm	Roses 30 x 50mm	Backplates 30 x 210mm PZ-72	Backplates 30 x 210mm PZ-92
19mm levers, complete	AA		C2190001	C2R190001H	C2L190001H	C2190201	C2190301	C2190501	C2190501	C2190101		
19mm levers for fire doors, complete	AA		C2390001	C2R390001H	C2L390001H	C2390201	C2390301	C2390501	C2390501	C2390101		
19mm levers, complete	BB		C2190003	C2R190003H	C2L190003H	C2190204	C2190304	C2190504	C2190504	C2190103		
19mm levers for fire doors, complete	BB		C2390003	C2R390003H	C2L390003H	C2390204	C2390304	C2390504	C2390504	C2390103		
19mm levers, complete	PZ		C2190007	C2R190007H	C2L190007H	C2190208	C2190308	C2190508	C2190508	C2190107	C2190908	C2191109
19mm levers for fire doors, complete	PZ		C2390007	C2R390007H	C2L390007H	C2390208	C2390308	C2390508	C2390508	C2390107	C2390908	C2391109
19mm levers, complete	BL		C2190024	C2R190024H	C2L190024H					C2190124		
19mm levers for fire doors, complete	BL		C2390024	C2R390024H	C2L390024H					C2390124		
19mm levers, complete	WC		C2190026			C2190229	C2190329	C2190529	C2190629			
19mm levers, complete	WC disabled		C2190032									
Set with fixed exterior knob	Right PZ		C2RCK190010			C2RCK190211	C2RCK190311	C2RCK190511	C2RCK190611			
	Right PZ		C2RKK190010			C2RKK190211	C2RKK190311	C2RKK190511	C2RKK190611			
	Right PZ		C2RFK190010			C2RFK190211	C2RFK190311	C2RFK190511	C2RFK190611			
	Left PZ		C2LCK190010			C2LCK190211	C2LCK190311	C2LCK190511	C2LCK190611			
	Left PZ		C2LKK190010			C2LKK190211	C2LKK190311	C2LKK190511	C2LKK190611			
	Left PZ		C2LFK190010			C2LFK190211	C2LFK190311	C2LFK190511	C2LFK190611			





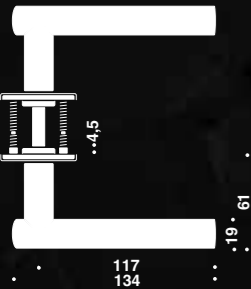



Lever B Shape

Welding and metal bending techniques are normally employed independently of one another. The **d line** lever in B shape is the result of combining these two techniques. Utilizing the latest improvements in welding, Knud Holscher manages to obtain other expressive values from his minimalistic concept. Though its shape deviates from that of its predecessors, the B lever immediately falls in with the **d line** family, primarily as a result of the slender elegance of its curve.



Standard Specification:
 Door thickness 33-59mm
 Door thickness, bathroom 34-48mm
 Conform to EN1906
 For different door thicknesses please specify









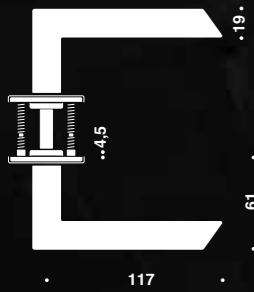







												
			Roses Ø50mm	1/2 Set Roses Right Ø50mm	1/2 Set Roses Left Ø50mm	Backplates 60 x 170mm	Backplates 60 x 210mm	Square Backplates Right 175 x 175mm	Square Backplates Left 175 x 175mm	Roses 30 x 50mm	Backplates 30 x 210mm PZ-72	Backplates 30 x 210mm PZ-92
16mm levers, complete	AA		B190001	BR190001H	BL190001H	B190201	B190301	B190501	B190501	B190101		
19mm levers, complete	AA		B390001	BR390001H	BL390001H	B390201	B390301	B390501	B390501	B390101		
19mm levers for fire doors, complete	AA											
16mm levers, complete	BB		B190003	BR190003H	BL190003H	B190204	B190304	B190504	B190504	B190103		
19mm levers, complete	BB	ⓘ	B390003	BR390003H	BL390003H	B390204	B390304	B390504	B390504	B390103		
19mm levers for fire doors, complete	BB											
16mm levers, complete	PZ		B190007	BR190007H	BL190007H	B190208	B190308	B190508	B190508	B190107	B190908	B191109
19mm levers, complete	PZ	ⓘ	B390007	BR390007H	BL390007H	B390208	B390308	B390508	B390508	B390107	B390908	B391109
19mm levers for fire doors, complete	PZ											
16mm levers, complete	BL		B190024	BR190024H	BL190024H					B190124		
19mm levers, complete	BL	●	B390024	BR390024H	BL390024H					B390124		
19mm levers for fire doors, complete	BL											
16mm levers, complete	WC		B190026			B190229	B190329	B190529	B190629			
19mm levers, complete	WC	☺										
19mm levers for fire doors, complete	WC											
16mm levers, complete	WC disabled		B190032									
19mm levers, complete	WC disabled	☹										
19mm levers for fire doors, complete	WC disabled											
Set with fixed exterior knob	Right PZ		BRCK190010			BRCK190211	BRCK190311	BRCK190511	BRCK190511			
	Right PZ	ⓘ	BRKK190010			BRKK190211	BRKK190311	BRKK190511	BRKK190511			
	Right PZ		BRFK190010			BRFK190211	BRFK190311	BRFK190511	BRFK190511			
	Left PZ		BLCK190010			BLCK190211	BLCK190311		BLCK190611			
	Left PZ	ⓘ	BLKK190010			BLKK190211	BLKK190311		BLKK190611			
	Left PZ		BLFK190010			BLFK190211	BLFK190311		BLFK190611			

Lever FF Shape

Sometimes design means reviewing the existing. For regardless of both outset and approach, the same result is never achieved twice. In other words, the idea behind the FF lever is unchanged when compared to older models, but the material is treated somewhat differently. New methods of production were prerequisites for translating idea into practice. Model FF became the first d line product to reach a satisfactory level of integration between welded elements and design cohesion.



Standard Specification:
 Door thickness 33-59mm
 Door thickness, bathroom 34-48mm
 Conform to EN1906
 For different door thicknesses please specify

											
			Roses Ø50mm	1/2 Set Roses Ø50mm	Backplates 60 x 170mm	Backplates 60 x 210mm	Square Backplates Right 175 x 175mm	Square Backplates Left 175 x 175mm	Roses 30 x 50mm	Backplates 30 x 210mm PZ-72	Backplates 30 x 210mm PZ-92
19mm levers, complete	AA		FF190001	FF190001H	FF190201	FF190301	FF190501	FF190501	FF190101		
19mm levers for fire doors, complete	AA		FF390001	FF390001H	FF390201	FF390301	FF390501	FF390501	FF390101		
19mm levers, complete	BB		FF190003	FF190003H	FF190204	FF190304	FF190504	FF190504	FF190103		
19mm levers for fire doors, complete	BB		FF390003	FF390003H	FF390204	FF390304	FF390504	FF390504	FF390103		
19mm levers, complete	PZ		FF190007	FF190007H	FF190208	FF190308	FF190508	FF190508	FF190107	FF190908	FF191109
19mm levers for fire doors, complete	PZ		FF390007	FF390007H	FF390208	FF390308	FF390508	FF390508	FF390107	FF390908	FF391109
19mm levers, complete	BL		FF190024	FF190024H					FF190124		
19mm levers for fire doors, complete	BL		FF390024	FF390024H					FF390124		
19mm levers, complete	WC		FF190026		FF190229	FF190329	FF190529	FF190629			
19mm levers, complete	WC disabled		FF190032								
Set with fixed exterior knob	PZ		FFCK190010		FFCK190211	FFCK190311	FFCK190511	FFCK190611			
	PZ		FFKK190010		FFKK190211	FFKK190311	FFKK190511	FFKK190611			
	PZ		FFFK190010		FFFK190211	FFFK190311	FFFK190511	FFFK190611			

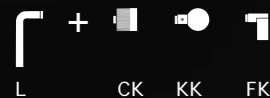







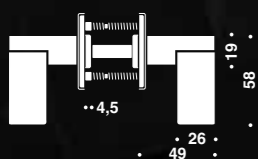



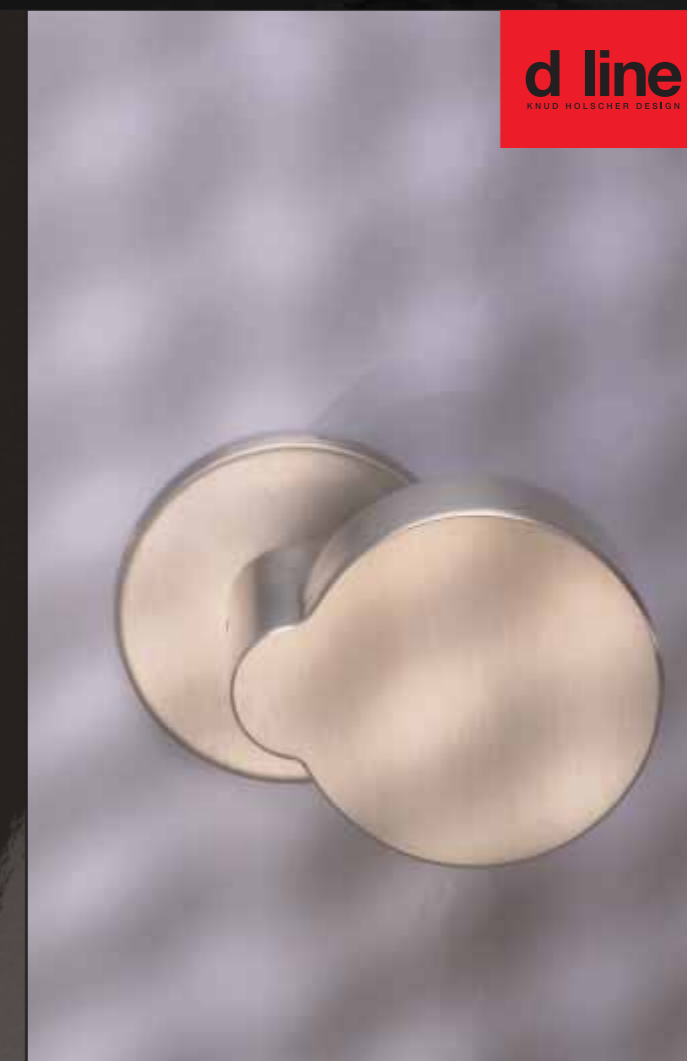







Knob FK Shape

To **d line**, it is important to be able to offer architects and specifiers a variety of different solutions within a unified design concept. It is in light of this philosophy that the rather untraditional FK lever, or knob, should be interpreted. The FK adds a very characteristic expression to the otherwise even lines favoured by Holscher and thus widens the lever range from which new options of combination also arise.



Standard Specification:
 Door thickness 33-49mm
 Door thickness, bathroom 34-48mm
 Conform to EN1906
 For different door thicknesses please specify



											
			Roses Ø50mm	1/2 Set Roses Ø50mm	Backplates 60 x 170mm	Backplates 60 x 210mm	Square Backplates Right 175 x 175mm	Square Backplates Left 175 x 175mm	Roses 30 x 50mm	Backplates 30 x 210mm PZ-72	Backplates 30 x 210mm PZ-92
19mm levers, complete	AA		FK190001	FK190001H	FK190201	FK190301	FK190501	FK190501	FK190101		
19mm levers for fire doors, complete	AA		FK390001	FK390001H	FK390201	FK390301	FK390501	FK390501			
19mm levers, complete	BB		FK190003	FK190003H	FK190204	FK190304	FK190504	FK190504	FK190103		
19mm levers for fire doors, complete	BB		FK390003	FK390003H	FK390204	FK390304	FK390504	FK390504			
19mm levers, complete	PZ		FK190007	FK190007H	FK190208	FK190308	FK190508	FK190508	FK190107	FK190908	FK191109
19mm levers for fire doors, complete	PZ		FK390007	FK390007H	FK390208	FK390308	FK390508	FK390508			
19mm levers, complete	BL		FK190024						FK190124		
19mm levers for fire doors, complete	BL		FK390024								
19mm levers, complete	WC		FK190026		FK190229	FK190329	FK190529	FK190629			
19mm levers, complete	WC disabled		FK190032								
Set with fixed exterior knob	PZ		FKFK190010		FKFK190211	FKFK190311	FKFK190511	FKFK190611			
	PZ										
	PZ										

FK FK

Knob KK Shape

The KK shape is closer akin to traditional types of door knobs, but with a simplicity that clearly bears the mark of Knud Holscher's understated aestheticism. Similarly, the polished and refined steel surface reveals the **d line** origin of KK. The subtle appearance of its form exudes a certain calmness which is extremely appealing.

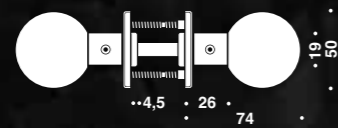

Standard Specification:
 Door thickness 33-49mm
 Door thickness, bathroom 34-48mm
 Conform to EN1906
 For different door thicknesses please specify



19mm levers, complete	AA		KK190001	KK190001H	KK190201	KK190301	KK190501	KK190501	KK190101		
19mm levers for fire doors, complete	AA		KK390001	KK390001H	KK390201	KK390301	KK390501	KK390501			
19mm levers, complete	BB	ⓘ	KK190003	KK190003H	KK190204	KK190304	KK190504	KK190504	KK190103		
19mm levers for fire doors, complete	BB		KK390003	KK390003H	KK390204	KK390304	KK390504	KK390504			
19mm levers, complete	PZ	ⓘ	KK190007	KK190007H	KK190208	KK190308	KK190508	KK190508	KK190107	KK190908	KK191109
19mm levers for fire doors, complete	PZ		KK390007	KK390007H	KK390208	KK390308	KK390508	KK390508			
19mm levers, complete	BL	●	KK190024						KK190124		
19mm levers for fire doors, complete	BL		KK390024								
19mm levers, complete	WC	☺ ☹	KK190026		KK190229	KK190329	KK190529	KK190629			
19mm levers, complete	WC disabled	☺ ☹	KK190032								
Set with fixed exterior knob	PZ	ⓘ	KKKK190010		KKKK190211	KKKK190311	KKKK190511	KKKK190611			
	PZ										
	PZ										

KK KK

Knob CK Shape





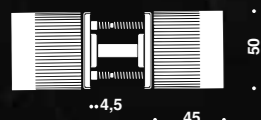











Good design endures. It is more than thirty years since this classic model in the d line door knob series emerged. Knud Holscher gave it a cylindrical shape which continues to distinguish this product from all other models in the series. Prominent features of the CK knob are extreme strength, stability, and endurance, making it an exponent of the high production standards maintained by d line.



Standard Specification:

Door thickness 33-64mm
 Door thickness, bathroom 34-48mm
 Conform to EN1906

For different door thicknesses please specify

											
			Roses Ø50mm	1/2 Set Roses Ø50mm	Backplates 60 x 170mm	Backplates 60 x 210mm	Square Backplates Right 175 x 175mm	Square Backplates Left 175 x 175mm	Roses 30 x 50mm	Backplates 30 x 210mm PZ-72	Backplates 30 x 210mm PZ-92
19mm levers, complete	AA		CK190001	CK190001H	CK190201	CK190301	CK190501	CK190501			
19mm levers for fire doors, complete	AA		CK390001	CK390001H	CK390201	CK390301	CK390501	CK390501			
19mm levers, complete	BB		CK190003	CK190003H	CK190204	CK190304	CK190504	CK190504			CK190103
19mm levers for fire doors, complete	BB		CK390003	CK390003H	CK390204	CK390304	CK390504	CK390504			
19mm levers, complete	PZ		CK190007	CK190007H	CK190208	CK190308	CK190508	CK190508		CK190908	CK191109
19mm levers for fire doors, complete	PZ		CK390007	CK390007H	CK390208	CK390308	CK390508	CK390508			
19mm levers, complete	BL		CK190024								CK190124
19mm levers for fire doors, complete	BL		CK390024								
19mm levers, complete	WC		CK190026		CK190229	CK190329	CK190529	CK190629			
19mm levers, complete	WC disabled		CK190032								
Set with fixed exterior knob	PZ		CKCK190010		CKCK190211	CKCK190311	CKCK190511	CKCK190611			
	PZ										
	PZ										

CK CK

Lever Accessories

The **d line** range includes a vast collection of accessories for fitting levers. All these items are carefully designed to meet the requirements of other **d line** products, and their inherent flexibility allows them to be adjusted to external parameters as well.

This double-page spread offers a view of some of the most commonly used parts.

Rigidiser for Fixed Levers
Backset = 60mm, length = 90mm, 8 x 8mm,
fixing centres 38mm

14.2921.02.060

d line
KNUD HOLSCHER DESIGN



When specifying spindle length for single-sided lever fixings please follow the guidelines in the sketches to the right.

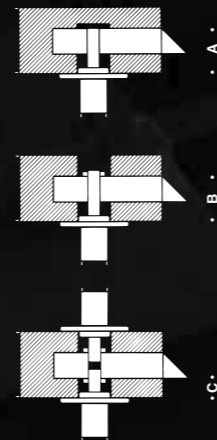

Spindles

	For single-sided fixing without boring through the other face of the door, galvanized steel 8 x 8mm	Distance A Distance A	30-39mm 39-48mm	14.2800.92.801 14.2800.92.802
	For single-sided fixing when boring through the other face of the door, galvanized steel 8 x 8mm	Distance B Distance B	20-29mm 27-36mm	14.2805.92.801 14.2805.92.802
	For single-sided fixing to lock cases with split follower. Panic escape function, galvanized steel 9 x 9mm	Distance C Distance C Distance C Distance C	8-17mm 17-26mm 26-35mm 35-44mm	14.2810.92.901 14.2810.92.902 14.2810.92.903 14.2810.92.904
	Split spindle for fixing to lock cases with split follower. Panic escape function, galvanized steel 9 x 9mm	Door thickness Door thickness Door thickness	35-59mm 59-85mm 85-111mm	14.2811.92.901 14.2811.92.902 14.2811.92.903
	Split spindle for fixation to lock cases with split follower. Panic for fixation, galvanized steel 8 x 8mm	Door thickness Door thickness Door thickness	35-59mm 59-85mm 85-111mm	14.2811.92.801 14.2811.92.802 14.2811.92.803
	Spindle for lever/knob comb, 8 x 8 x 55mm with M6 thread	Door thickness	35-45 mm	14.2840.92.801
	Spindle for lever/knob comb, 8 x 8 x 85mm with M6 thread	Door thickness	55-65 mm	14.2840.92.802
	Spindle for lever/knob comb, 9 x 9 x 55mm with M6 thread	Door thickness	35-45 mm	14.2840.92.901
	Spindle for lever/knob comb, 9 x 9 x 85mm with M6 thread	Door thickness	55-65 mm	14.2840.92.902
	Spindle for fixing lever handles L, U, C, B and FF and knobs FK, KK, CK in pairs, galvanized steel 8 x 8mm	Door thickness Door thickness Door thickness	33-59mm 59-85mm 85-111mm	D0.0000.01.440 D0.0000.01.441 D0.0000.01.447
	Spindle for fixing lever handles U2, UF, M and C2 in pairs, galvanized steel 8 x 8mm	Door thickness Door thickness Door thickness Door thickness Door thickness	33-44mm 44-60mm 60-76mm 76-92mm 92-108mm	D0.0000.01.443 D0.0000.01.440 D0.0000.01.445 D0.0000.01.779 D0.0000.01.447

Escutcheons

	Roses with ball bearing. Supplied singly without screws, with holes for M4 machine screws or screws csk 4.0mm. Fixing centres 30 and 38mm	To suit 16mm lever handles To suit 19mm lever handles	14.3216.02.607 14.3216.02.909		
	Cylinder escutcheon with threaded bushes M5 for euro profile cylinder, without screws. Fixing centres 38mm	Height Height Height Height Height	6mm 8mm 11mm 13mm 16mm 18mm 14.3444.02.061 14.3444.02.087 14.3444.02.117 14.3444.02.133 14.3444.02.168 14.3444.02.184		
	Cylinder escutcheon for euro profile cylinder with holes for machine screws M5, without screws. Fixing centres 38mm	Height Height	6mm 8mm 14.3454.02.064 14.3454.02.081		
	For Union with snap-on cover, with holes for M4 machine screws. Fixing centres 38mm		14.3435.02.223		
	For euro standard with snap-on cover, with holes for M4 machine screws. Fixing centres 38mm		14.3435.02.215		
	Blank rose used together with safety security escutcheon with threaded bushes for ASSA, Boda and Trioving, with snap-on cover, with holes for M5 machine screws. Fixing centres 30mm		14.3465.02.100		
	With red/white indicator and emergency release, complete with inside snib turn and 4.5 x 75mm through fixings. Suitable for door thickness 34-48mm. Fixing centres spindle turn action	30mm 38mm 38mm 38mm	5mm 8mm 5mm 6mm	90° 90° 90° 90°	14.3475.02.115 14.3475.02.309 14.3475.02.457 14.3475.02.503

Pull Handles

Simplicity in design, solidity in operation. These basic characteristics are discernable in every item and detail due to the intrinsic quality and craftsmanship of d line. Thus, in every phase of the production process, questions of design and function are carefully weighed against each another; this explains why many of the products' technical features are concealed behind a subtle stainless steel exterior.



Safety

To **d line**, impeccable design solutions and remarkable functionalism are not the only considerations; even when on the drawing board, a prevalent concern is that of safety. Fittings should be easy to understand and must in no way impair people's freedom of movement in a given environment. Hence, Knud Holscher is very conscious of how round or curved shapes imply an element of safety, important not least in schools, sheltered housing or projects for the less able.

Through years of co-operation with architects and engineers, **d line** has gained invaluable experience in dealing with practical problems on site. Each time **d line** is involved in a project, new lessons are learned for the benefit of future products. This is an important reason why **d line** has long been able to meet safety requirements, even in highly complicated architectural environments.



Fixing Tool
 For threaded bolt M8 14.4971.92.006
 For threaded bolt M10 14.4972.92.001
 For threaded bolt M12 14.4972.92.001

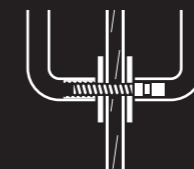
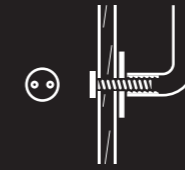
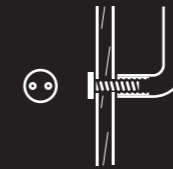

Threaded Bolts		
M8	Length 30mm	14.4920.02.306
	Length 60mm	14.4920.02.608
	Length 90mm	14.4920.02.900
M10	Length 30mm	14.4922.02.305
	Length 60mm	14.4922.02.607
	Length 90mm	14.4922.02.909
M12	Length 30mm	14.4921.02.301
	Length 60mm	14.4921.02.602
	Length 100mm	14.4921.02.106



Straight Pulls

d line pull handles adhere to the stringent design principles of Knud Holscher. The proportions of standard lengths make them particularly suitable for a wide range of applications. Fixing options are equally broad. Wood, glass, and steel doors can be fitted with tried and tested components. The solid stability of these fittings is evidenced by the fact that they are regularly used as grab handles in toilet areas and swimming pools. They can be mounted in either vertical or horizontal positions and the concealed screw fixings do not detract from the design qualities. In Ø14mm or Ø19mm these designs are well-suited for cupboard doors or drawers.



Standard Specification:	
Door thickness	38-48mm
Thickness, glass doors	8-18mm

For different door thicknesses please specify



Without Roses



With Roses



Without Roses



Without Roses for Glass



With Roses



With Roses for Glass



Without Roses



With Roses



Without Roses



Without Roses for Glass



With Roses



With Roses for Glass

Ø x L x H

14mm pull handle with fixing accessories	14	45	45	PS1404501	PS1404502	PS1404503	PS1404504	PS1404505	PS1404506							
14mm pull handle with fixing accessories	14	125	50	PS1412501	PS1412502	PS1412503	PS1412504	PS1412505	PS1412506							
14mm pull handle with fixing accessories	14	300	50	PS1430001	PS1430002	PS1430003	PS1430004	PS1430005	PS1430006	PS1412507	PS1412508	PS1412509	PS1412510	PS1412511	PS1412512	
14mm pull handle with fixing accessories	14	650	50	PS1465001	PS1465002	PS1465003	PS1465004	PS1465005	PS1465006	PS1430007	PS1430008	PS1430009	PS1430010	PS1430011	PS1430012	
19mm pull handle with fixing accessories	19	125	65	PS1912501	PS1912502	PS1912503	PS1912504	PS1912505	PS1912506	PS1912507	PS1912508	PS1912509	PS1912510	PS1912511	PS1912512	
19mm pull handle with fixing accessories	19	200	65	PS1920001	PS1920002	PS1920003	PS1920004	PS1920005	PS1920006	PS1920007	PS1920008	PS1920009	PS1920010	PS1920011	PS1920012	
19mm pull handle with fixing accessories	19	300	65	PS1930001	PS1930002	PS1930003	PS1930004	PS1930005	PS1930006	PS1930007	PS1930008	PS1930009	PS1930010	PS1930011	PS1930012	
19mm pull handle with fixing accessories	19	650	65	PS1965001	PS1965002	PS1965003	PS1965004	PS1965005	PS1965006	PS1965007	PS1965008	PS1965009	PS1965010	PS1965011	PS1965012	
25mm pull handle with fixing accessories	25	300	70	PS2530001	PS2530002	PS2530003	PS2530004	PS2530005	PS2530006	PS2530007	PS2530008	PS2530009	PS2530010	PS2530011	PS2530012	
25mm pull handle with fixing accessories	25	650	70	PS2565001	PS2565002	PS2565003	PS2565004	PS2565005	PS2565006	PS2565007	PS2565008	PS2565009	PS2565010	PS2565011	PS2565012	
32mm pull handle with fixing accessories	32	300	80	PS3230001	PS3230002	PS3230003	PS3230004	PS3230005	PS3230006	PS3230007	PS3230008	PS3230009	PS3230010	PS3230011	PS3230012	
32mm pull handle with fixing accessories	32	650	80	PS3265001	PS3265002	PS3265003	PS3265004	PS3265005	PS3265006	PS3265007	PS3265008	PS3265009	PS3265010	PS3265011	PS3265012	

Cranked Pulls

Bent at right angles to match the LF and UF levers, the **d line** cranked pulls maintain a unified appearance and therefore make a popular choice for glass and narrow stile doors for e.g. commercial buildings.

The elegance of the simple design stands out in sharp relief when the handles are fitted back-to-back on double glass doors. Screw fixings are as always concealed. They have a reassuring feel in use.



Standard Specification:
 Door thickness 38-48mm
 Thickness, glass doors 8-18mm

For different door thicknesses please specify



Without Roses



With Roses



Without Roses



Without Roses for Glass



With Roses



With Roses for Glass



Without Roses



With Roses



Without Roses



Without Roses for Glass



With Roses



With Roses for Glass

	Ø	x	L	x	H	x	h													
14mm pull handle with fixing accessories	14	125	50	60	PO1412501	PO1412502	PO1412503	PO1412504	PO1412505	PO1412506	PO1412507	PO1412508	PO1412509	PO1412510	PO1412511	PO1412512				
14mm pull handle with fixing accessories	14	300	50	60	PO1430001	PO1430002	PO1430003	PO1430004	PO1430005	PO1430006	PO1430007	PO1430008	PO1430009	PO1430010	PO1430011	PO1430012				
14mm pull handle with fixing accessories	14	650	50	60	PO1465001	PO1465002	PO1465003	PO1465004	PO1465005	PO1465006	PO1465007	PO1465008	PO1465009	PO1465010	PO1465011	PO1465012				
19mm pull handle with fixing accessories	19	125	65	73	PO1912501	PO1912502	PO1912503	PO1912504	PO1912505	PO1912506	PO1912507	PO1912508	PO1912509	PO1912510	PO1912511	PO1912512				
19mm pull handle with fixing accessories	19	300	65	73	PO1930001	PO1930002	PO1930003	PO1930004	PO1930005	PO1930006	PO1930007	PO1930008	PO1930009	PO1930010	PO1930011	PO1930012				
19mm pull handle with fixing accessories	19	650	65	73	PO1965001	PO1965002	PO1965003	PO1965004	PO1965005	PO1965006	PO1965007	PO1965008	PO1965009	PO1965010	PO1965011	PO1965012				
25mm pull handle with fixing accessories	25	300	70	95	PO2530001	PO2530002	PO2530003	PO2530004	PO2530005	PO2530006	PO2530007	PO2530008	PO2530009	PO2530010	PO2530011	PO2530012				
25mm pull handle with fixing accessories	25	650	70	95	PO2565001	PO2565002	PO2565003	PO2565004	PO2565005	PO2565006	PO2565007	PO2565008	PO2565009	PO2565010	PO2565011	PO2565012				
32mm pull handle with fixing accessories	32	300	80	100	PO3230001	PO3230002	PO3230003	PO3230004	PO3230005	PO3230006	PO3230007	PO3230008	PO3230009	PO3230010	PO3230011	PO3230012				
32mm pull handle with fixing accessories	32	650	80	110	PO3265001	PO3265002	PO3265003	PO3265004	PO3265005	PO3265006	PO3265007	PO3265008	PO3265009	PO3265010	PO3265011	PO3265012				

Circular Pulls

A synthesis of Knud Holscher's well-disciplined pencil and unique methods of metal bending, these handles describe a slender curve completing itself in a circle when the handles are mounted in pairs. This 'rounded' view imparts an impression of harmony well-suited for centrally placed doors. By virtue of this and other qualities, the circular handles constitute an almost organic addition to the d line range.



Standard Specification:
 Door thickness 38-48mm
 Thickness, glass doors 8-18mm

For different door thicknesses please specify



■ Knob Handle (Ø x H)
 For glass door
 For wooden door

51 x 52mm 14.3040.02.019	130 x 59mm 14.3050.02.010 14.3050.02.020	130 x 59mm 14.3050.02.910 (threaded) 14.3050.02.900 (bush head)

■ Elbow Pulls (Ø x L x H)
 For wooden doors



Without Roses	With Roses	Without Roses	Without Roses for Glass	With Roses	With Roses for Glass	Without Roses	With Roses	Without Roses	Without Roses for Glass	With Roses	With Roses for Glass

■ Circular Pulls

	Ø	x	L	x	H	x	X
19mm pull handle with fixing accessories	19	200	65	50			
32mm pull handle with fixing accessories	32	300	80	60			

PC1920001	PC1920002	PC1920003	PC1920004	PC1920005	PC1920006	PC1920007	PC1920008	PC1920009	PC1920010	PC1920011	PC1920012
PC3230001	PC3230002	PC3230003	PC3230004	PC3230004	PC3230006	PC3230007	PC3230008	PC3230009	PC3230010	PC3230011	PC3230012



Heavy Straight Pulls

Radiating elegance and solidity, these handles benefit from robustness of both material and construction. A combination of stability and formality make this solution an obvious choice for entrance doors, both large and small, internally and externally. In the latter case, the visual weight of this design adds an impression of quality and worth to any facade.

These handles are manufactured to special dimensions to suit individual projects.



Standard Specification:
 Door thickness 38-48mm
 Thickness, glass doors 8-18mm

For different door thicknesses please specify

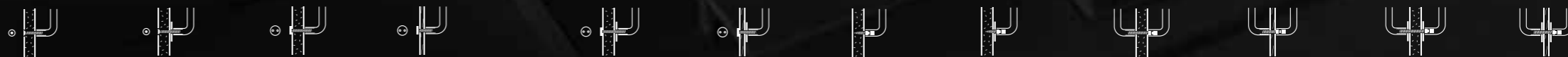

A	Without Roses		With Roses		Without Roses for Glass		With Roses for Glass		Without Roses		With Roses		Without Roses for Glass		With Roses		Without Roses for Glass		With Roses		Without Roses for Glass		With Roses	
	Without Roses	With Roses	Without Roses	With Roses	Without Roses for Glass	With Roses for Glass	Without Roses	With Roses	Without Roses	With Roses	Without Roses for Glass	With Roses	Without Roses for Glass	With Roses	Without Roses for Glass	With Roses	Without Roses for Glass	With Roses	Without Roses for Glass	With Roses	Without Roses for Glass	With Roses		
0-700	PB380701	PB380702	PB380703	PB380704	PB380705	PB380706	PB380707	PB380708	PB380709	PB380710	PB380711	PB380712	PB380713	PB380714	PB380715	PB380716	PB380717	PB380718	PB380719	PB380720	PB380721	PB380722	PB380723	PB380724
701-900	PB380901	PB380902	PB380903	PB380904	PB380905	PB380906	PB380907	PB380908	PB380909	PB380910	PB380911	PB380912	PB380913	PB380914	PB380915	PB380916	PB380917	PB380918	PB380919	PB380920	PB380921	PB380922	PB380923	PB380924
901-1100	PB381101	PB381102	PB381103	PB381104	PB381105	PB381106	PB381107	PB381108	PB381109	PB381110	PB381111	PB381112	PB381113	PB381114	PB381115	PB381116	PB381117	PB381118	PB381119	PB381120	PB381121	PB381122	PB381123	PB381124
1101-1300	PB381301	PB381302	PB381303	PB381304	PB381305	PB381306	PB381307	PB381308	PB381309	PB381310	PB381311	PB381312	PB381313	PB381314	PB381315	PB381316	PB381317	PB381318	PB381319	PB381320	PB381321	PB381322	PB381323	PB381324
1301-1500	PB381501	PB381502	PB381503	PB381504	PB381505	PB381506	PB381507	PB381508	PB381509	PB381510	PB381511	PB381512	PB381513	PB381514	PB381515	PB381516	PB381517	PB381518	PB381519	PB381520	PB381521	PB381522	PB381523	PB381524
1501-1600	PB381601	PB381602	PB381603	PB381604	PB381605	PB381606	PB381607	PB381608	PB381609	PB381610	PB381611	PB381612	PB381613	PB381614	PB381615	PB381616	PB381617	PB381618	PB381619	PB381620	PB381621	PB381622	PB381623	PB381624
1601-1700	PB381701	PB381702	PB381703	PB381704	PB381705	PB381706	PB381707	PB381708	PB381709	PB381710	PB381711	PB381712	PB381713	PB381714	PB381715	PB381716	PB381717	PB381718	PB381719	PB381720	PB381721	PB381722	PB381723	PB381724
1701-1800	PB381801	PB381802	PB381803	PB381804	PB381805	PB381806	PB381807	PB381808	PB381809	PB381810	PB381811	PB381812	PB381813	PB381814	PB381815	PB381816	PB381817	PB381818	PB381819	PB381820	PB381821	PB381822	PB381823	PB381824
1801-1900	PB381901	PB381902	PB381903	PB381904	PB381905	PB381906	PB381907	PB381908	PB381909	PB381910	PB381911	PB381912	PB381913	PB381914	PB381915	PB381916	PB381917	PB381918	PB381919	PB381920	PB381921	PB381922	PB381923	PB381924
1901-2000	PB382001	PB382002	PB382003	PB382004	PB382005	PB382006	PB382007	PB382008	PB382009	PB382010	PB382011	PB382012	PB382013	PB382014	PB382015	PB382016	PB382017	PB382018	PB382019	PB382020	PB382021	PB382022	PB382023	PB382024
2001-2100	PB382101	PB382102	PB382103	PB382104	PB382105	PB382106	PB382107	PB382108	PB382109	PB382110	PB382111	PB382112	PB382113	PB382114	PB382115	PB382116	PB382117	PB382118	PB382119	PB382120	PB382121	PB382122	PB382123	PB382124
2101-2200	PB382201	PB382202	PB382203	PB382204	PB382205	PB382206	PB382207	PB382208	PB382209	PB382210	PB382211	PB382212	PB382213	PB382214	PB382215	PB382216	PB382217	PB382218	PB382219	PB382220	PB382221	PB382222	PB382223	PB382224
2201-2300	PB382301	PB382302	PB382303	PB382304	PB382305	PB382306	PB382307	PB382308	PB382309	PB382310	PB382311	PB382312	PB382313	PB382314	PB382315	PB382316	PB382317	PB382318	PB382319	PB382320	PB382321	PB382322	PB382323	PB382324
2301-2400	PB382401	PB382402	PB382403	PB382404	PB382405	PB382406	PB382407	PB382408	PB382409	PB382410	PB382411	PB382412	PB382413	PB382414	PB382415	PB382416	PB382417	PB382418	PB382419	PB382420	PB382421	PB382422	PB382423	PB382424
2401-2500	PB382501	PB382502	PB382503	PB382504	PB382505	PB382506	PB382507	PB382508	PB382509	PB382510	PB382511	PB382512	PB382513	PB382514	PB382515	PB382516	PB382517	PB382518	PB382519	PB382520	PB382521	PB382522	PB382523	PB382524
2501-2600	PB382601	PB382602	PB382603	PB382604	PB382605	PB382606	PB382607	PB382608	PB382609	PB382610	PB382611	PB382612	PB382613	PB382614	PB382615	PB382616	PB382617	PB382618	PB382619	PB382620	PB382621	PB382622	PB382623	PB382624

Door Stops

d line offers a technically refined series of door stops comprising both wall and floor mounted models, all of which are manufactured with great emphasis on strength and durability. However, these qualities are carefully concealed behind a minimal exterior. Since all items in d line's vast hardware range are designed to interact with one another, the dimensions of the door stops are compatible with other relevant product proportions.

Among the features of these components is a buffered door stop with coat hook. Also a recent addition to the series is a particularly heavy-duty door stop designed to withstand the duress of very heavy doors as well as abuse from mechanical sweepers or similar cleaning machines.

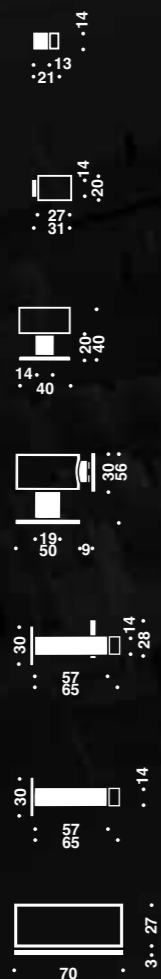
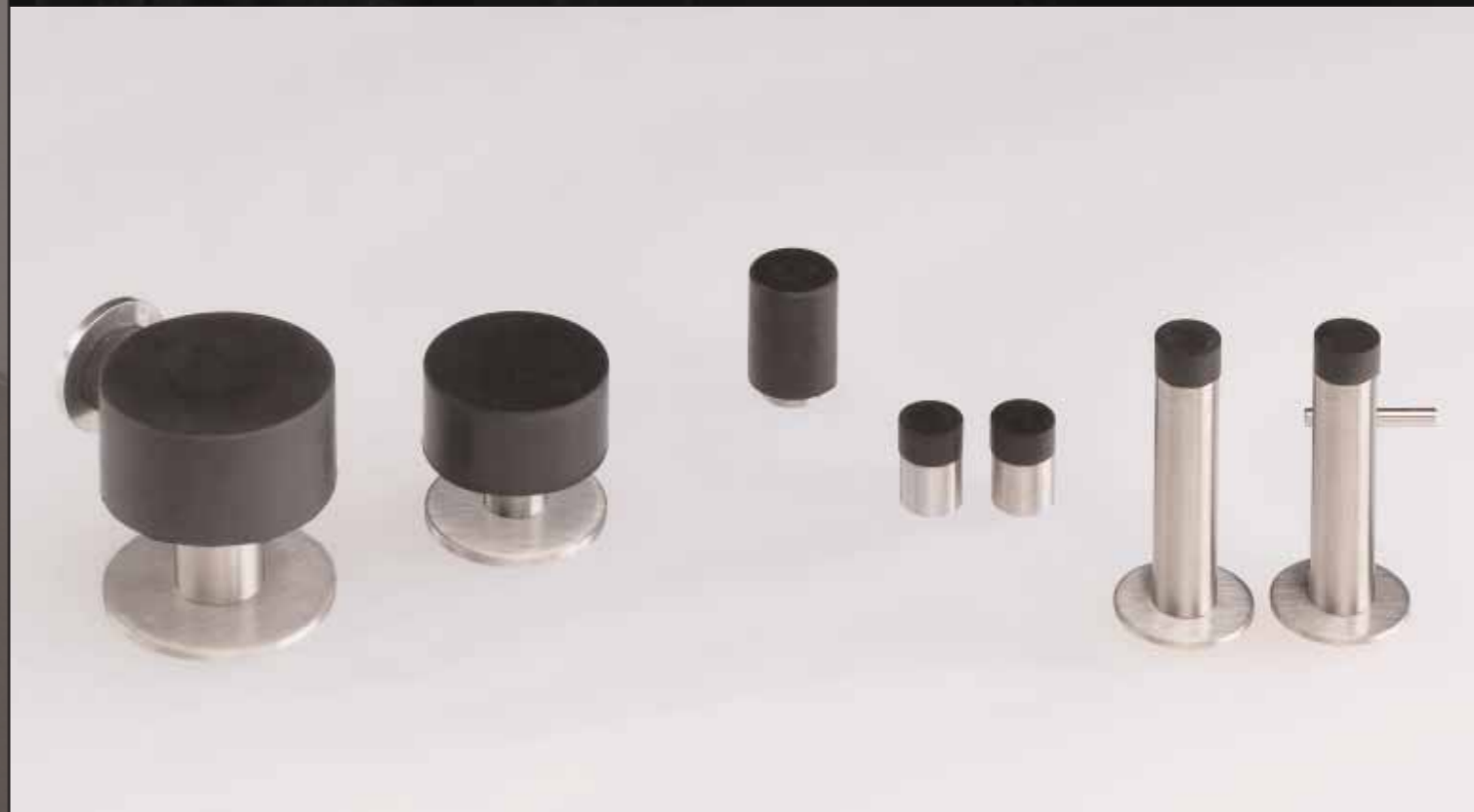

■ Door Stop for Floor Mounting



14.5070.02.006



14.5075.02.009



14.5080.02.000

■ Door Stop for Wall Mounting



14.5050.02.009



14.5055.02.001



14.5060.02.002



14.5065.02.005

Pulls and Flush Pulls, Miscellaneous

The series comprises six types of recessed handles for sliding doors. In addition to the circular and oval flush pulls, **d line** offers five different handles mounted on backplates of varying sizes. In addition a flush duct pull with an 8 x 8mm follower for operation of a lock case is available.



c/w fixings

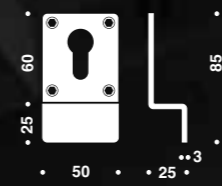
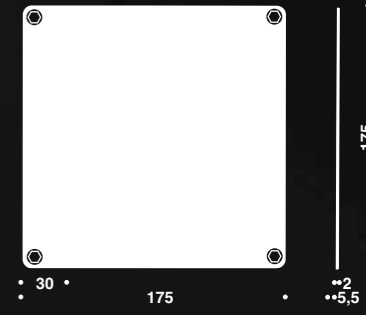

■ Duct Pull Handles, Spindle Required



Ø80mm
X = 15

14.3910.02.001

■ Flush Pull Handles



Ø50mm
X = 15

14.3900.02.051



Ø80mm
X = 17

14.3900.02.077



Ø115mm
X = 20

14.3900.02.115



50 x 102mm
X = 15

14.3950.02.105



58 x 175mm
X = 20

14.3950.02.164



175 x 175mm
X = 20

14.3970.02.111

■ Push Plates



60 x 210mm

14.3701.02.008



175 x 175mm

14.3776.02.006

■ Pull Plates



25 x 50mm
50 x 85mm

14.4011.02.125



14 x 125mm
60 x 175mm

14.4013.02.124

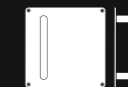

14 x 125mm
175 x 175mm

14.4211.01.121



19 x 125mm
60 x 175mm

14.4213.02.121



19 x 125mm
175 x 175mm

14.4213.02.121

Curves of Simplicity

Resulting from a synthesis of Knud Holscher's well-disciplined pencil and **d line's** unique methods of metal bending, the furniture handles benefit from a slender appearance and smoothly interacts with all other **d line** products.

On the drawing board a prevalent concern was that of user-friendliness. Thus, the rounded shapes of these handles not only give a pleasant feel, but also exude an element of safety, important not least in environments for children or elderly people. **d line's** characteristically curved lines provide the furniture handles with a subtle simplicity, aesthetically supported by the absence of visible welds. All fixings are concealed and mounting is simple.



Cabinet Knobs and Furniture Pulls

An increasingly important accessory **d line** drawer pulls and cabinet door handles, seven designs in total, began to dominate this particular category of the ironmongery market immediately after their release. The reason being their pleasant feel and appearance as well as concealed fixings which focus the eye of the user on the overall design.

Cabinet knobs and furniture pulls integrate well with other **d line** products and remain true to Knud Holscher's philosophy of simple uniformity.

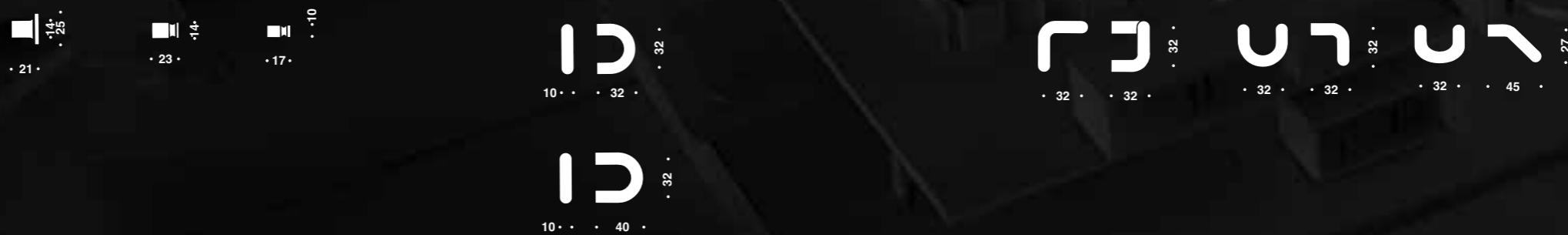

■ M5 Screws for Mounting (Sold Individually)

20mm	14.4900.92.201
25mm	14.4900.92.251
30mm	14.4900.92.308
35mm	14.4900.92.359

● ■ Bush	● ■ M5 Tread	■	■	□	□	□	□	□	□
14.5600.02.000	14.5600.02.107	14.5610.02.101	14.3816.02.011	14.3822.02.024	14.3842.02.030	14.3832.02.028	14.3852.02.025	14.3852.02.041	

Cabinet Handles

Designed in accordance with the principles used on lever L, **d line** furniture handles are in essence the epitome of furniture accessories and benefit from a simple, slender appearance. Technically, the challenge they posed to **d line** and Knud Holscher lay in obtaining a constant bend with a small radius.

All fixing dimensions are closely aligned with the relevant standards of the furniture industry and reflect a consistent aesthetic with other **d line** products.



■ Screws for Mounting (Sold Individually)

20mm	14.4900.92.201
25mm	14.4900.92.251
30mm	14.4900.92.308
35mm	14.4900.92.359



Ø10 x 96mm
14.3812.02.098



Ø10 x 128mm
14.3812.02.136



Ø10 x 224mm
14.3812.02.225

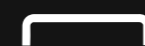

Ø10 x 320mm
14.3812.02.322

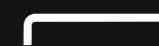

Ø10 x 416mm
14.3812.02.411

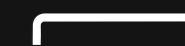

Ø10 x 512mm
14.3812.02.519



Indicators, Hinges and Bell Pushes

Surface Indicators

Doors commonly used for WC cubicles are often too thin to contain a lock case. Here, a surface mounted solution is available. In the traditional **d line** design, two types of bolts are included, a dead bolt and a hook bolt. Both contain a discreet red-white external indicator. Fixings for glass doors, hinged doors, and sliding doors are available. The dead lock allows for mounting on all types of doors, whereas the hook lock is reserved for sliding doors. A bolt with an easy-to operate turn has been specially developed for the less able.

Hinges and Bell Pushes

The visual impression of **d line** is completed with the inclusion of hinges and once again maintaining a constant aesthetic another tactile accessory is the bell push. Throughout, **d line** adheres to a design concept consistently unifying all details.

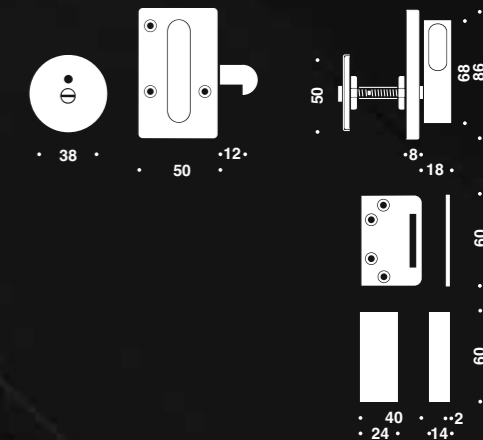

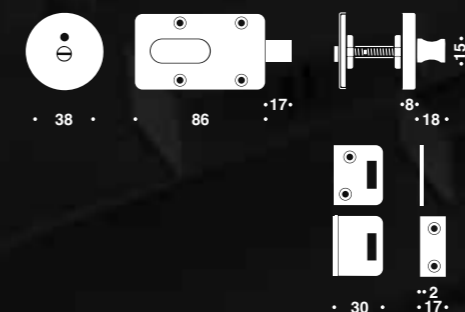

Standard Specification:

Door thickness	10-34mm
Door bolt, WC turn	34-48mm
Conforms to EN 1935	
For different door thicknesses please specify	



	
■ Butterfly Hinges	■ Lift-off Hinges, 96 x 89mm
102 x 89mm	
Rounded	Right
Square	Left
14.5003.02.000	14.5005.02.208
14.5003.02.001	14.5005.02.500

	
■ Bell Pushes	
Ø50mm	30 x 65mm
14.5016.02.001	14.5021.02.002

	
■ WC Surface Indicator	■ WC Surface Hook Lock
14.3476.02.028	
	Right
	Left
	14.3479.02.021
	14.3479.02.030

Door Signs

Modern buildings and environments demand new signage solutions as working practices evolve. The **d line** Sign Selection allows for a combination of simplicity yet high flexibility and aesthetic quality, main points that makes up a unique doorsign.



The stainless steel cut letter series comes in a variety of heights and thickness. All are characterized by precision and minimalism.

■ Lower-case Letters	a b c	a b c
4.0 x 75mm	14.3799.02.1xx	14.3799.02.2xx
10.0 x 150mm		

■ Capital Letters	A B C	A B C
4.0 x 75mm	14.3799.02.3xx	14.3799.02.4xx
10.0 x 150mm		

■ Numbers	1 2 3	1 2 3
4.0 x 75mm	14.3798.02.1xx	14.3798.02.2xx
10.0 x 150mm		



●	■	Frosted acrylic disc, Ø76mm	14.3797.02.xxx
		Frosted acrylic square disc, 86 x 86mm	14.3797.02.xxx
●	■	Stainless steel disc, Ø76mm	14.3797.02.xxx
		Stainless steel square disc, 86 x 86mm	14.3797.02.xxx
●		Stainless steel disc, Ø76/86mm	14.3797.02.xxx
		Stainless steel disc, screw fixed, Ø76/86mm	14.3797.02.xxx
		xxx = state required pictogram	
		Male, Female, Unisex and Disabled	



Fixing
Further the unique fixing system allows for flexibility – ability to shorten or extend the sign. Wall rail and male jigsaw are fixed to the wall; the female jigsaw (bonded to the panel) then slides into the male jigsaw to put the panel in place. The locking rod is pushed through the centre of the wall rail and jigsaws to secure the panels if additional security is required.

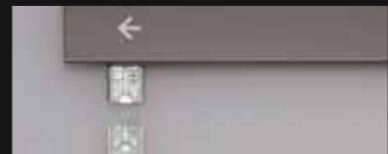

Panels, 4mm thick cut to modular sizes to 0.1mm tolerance

Brushed, 316 stainless steel, coarse grit with high polish fractal finish

Folio, 5% green ICI Perspex, 316 stainless steel holder, 0.2mm radius bends

Frosted, as folio but with Perspex glass bead blasted to fine pumice effect, special reflectant coating

Blasted, 316 stainless steel, glass bead blasted to fine pumice sparkle effect



Brushed SS 211 x 58mm	Frosted Folio 211 x 58mm	Blasted SS 211 x 28mm Folio 211 x 28mm	Folio 103.5 x 28mm	Brushed SS 211 x 28mm Folio 211 x 28mm	Brushed SS 211 x 58mm Folio 211 x 28mm	Brushed SS 103.5 x 58mm Folio 103.5 x 28mm	Brushed SS 211 x 58mm Folio 211 x 28mm Slider 211 x 28mm	Blasted SS 211 x 28mm Folio 211 x 28mm Slider 211 x 28mm
14.3797.02.404	14.3797.02.397	14.3797.02.391	14.3797.02.398	14.3797.02.385	14.3797.02.386	14.3797.02.399	14.3797.02.387	14.3797.02.392

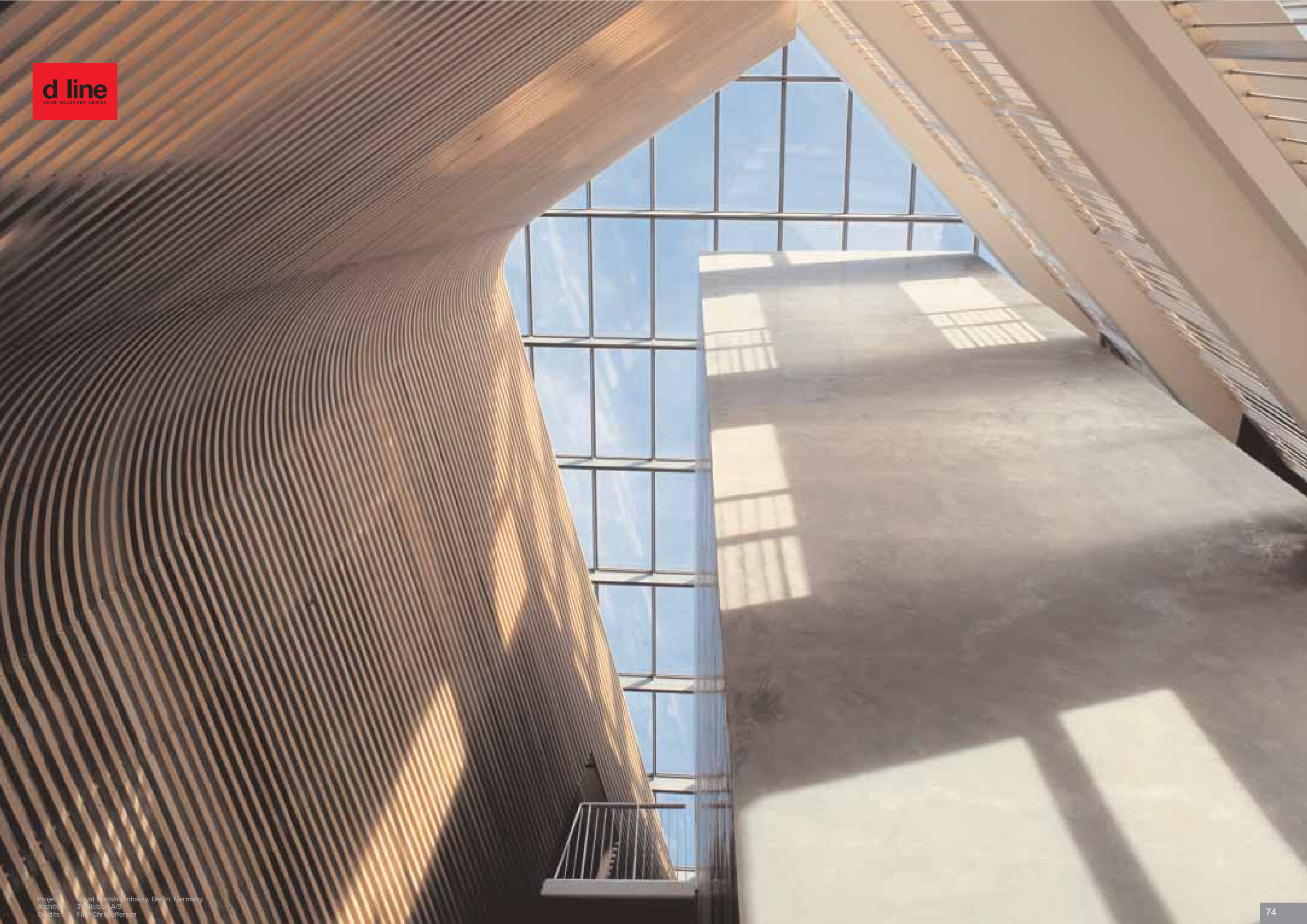

Window Levers



Consistency is paramount to **d line**. The design of the window levers therefore mirror that of door levers, allowing coherence which is so important to architects striving for visual continuity in a given environment. **d line** window handles comprise regular window levers for espagnolettes to tilt and turn gearing mechanisms.

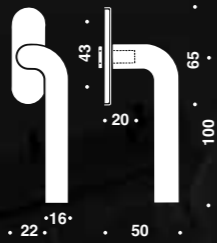

Standard Specification:
Spindle length for tilt-turn 33mm

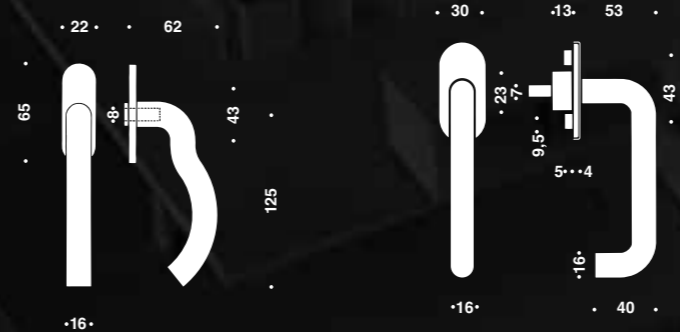

Icon	Icon	Icon	Icon	Icon	Icon
■ Straight Window Lever without Spindle (8 x 8mm)					
Rose 22 x 65mm	14.5412.02.000	14.5414.02.000	14.5409.02.000	14.5408.02.000	14.5440.02.000
				14.5407.02.000	

Icon	Icon
■ Cranked Espagnolette Bolt Handle wo/Spindle (7 x 7mm)	
Rose 22 x 65mm Right	14.5418.02.020
Rose 22 x 65mm Left	14.5418.02.050

Icon	Icon	Icon	Icon	Icon
■ Tilt-turn with Square Spindle (8 x 8mm)				
Rose 30 x 65mm	14.5420.02.035	14.5425.02.038	14.5422.02.038	14.5421.02.038
			14.5423.02.038	

■ Reduction Bush	14.5452.92.078					
■ Spindles	40mm	45mm	50mm	55mm	65mm	75mm
7 x 7mm		14.5454.92.459	14.5454.92.505	14.5454.92.556	14.5454.92.653	14.5454.92.751
8 x 8mm	14.5456.92.407	14.5456.92.458	14.5456.92.504	14.5456.92.555	14.5456.92.652	14.5456.92.750

Door Controls

As with the rest of the **d line** range, the door closers are conceived as part of a design totality. The curved door closer casings reflect the contours of the door levers to continue the harmonious aesthetic.

This is achieved by 'closing' the casings with fully radiused terminations, which, along with sharp bends and clean lines, results in an attractive yet understated visual impression that compliments rather than detracts from the overall aesthetic.

By virtue of its extensive product range, **d line** is able to offer solutions to technically demanding problems.

For example, electronic access control systems, which can accommodate the needs of even the largest projects, can be delivered with plans and technologically adapted solutions.

Each and every lock benefits from the **d line** cylinder series, which offers high quality and flexibility from standard to high-security applications.

An equally superior quality in use characterises the lock cases and panic exit devices from **d line**, which can also be found on the following pages.



Door Closers and Floor Springs

The **d line** overhead door closers with standard projecting armset follow the design guidelines of the entire range. The full radiused cover is instantly recognisable as a **d line** design classic. The 'engine' utilises well-proven hydraulic technology within a slim housing, yet it is powerful and robust. The result is an unbeatable door closer.

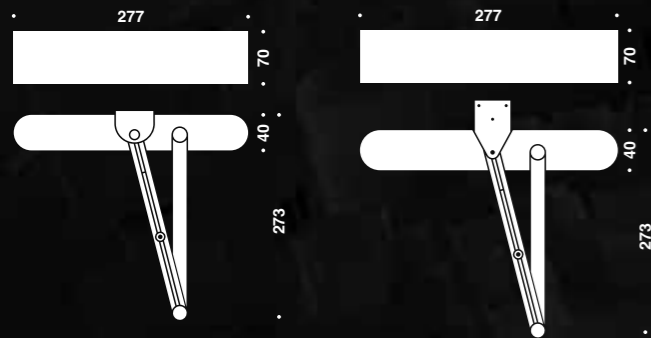

Standard Specification:
Conform to EN1154/EN1634

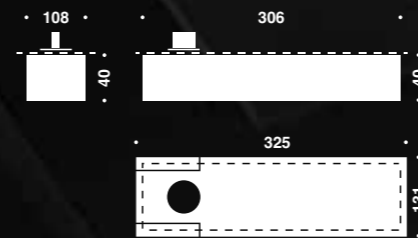

d line floor springs consist of a selection of high performance units. Top centre and strap shoes can be used for both single and double action door closers providing for high flexibility. Supplied complete with all components for fitting as a kit.



	EN Size	Face Fix Bracket	Soffit Bracket	Door Size	Door Size
				Max. Width	Max. Weight
■ Door Closers with Arm					
Back check function, hydraulic latch action, speed control	2-5	14.5302.02.000	14.5302.02.001	1100	100
Back check function, hydraulic latch action, Delayed closure, speed control	2-5	14.5302.02.020	14.5302.02.021	1100	100
Soffit bracket for parallel mounting, fig 6			14.5373.02.049		



	EN Size	Single Action	Single Action	Double Action	Door Size
		Right	Left		
■ Floor Springs, c/w Acc.					
Back check function, speed control	2	14.5310.02.012	14.5310.02.022	14.5310.02.002	700
Back check function, speed control	3	14.5310.02.013	14.5310.02.023	14.5310.02.003	900
Back check function, speed control	4	14.5310.02.014	14.5310.02.024	14.5310.02.004	1100
Back check function, speed control, HO	2	14.5310.02.042	14.5310.02.052	14.5310.02.032	
Back check function, speed control, HO	3	14.5310.02.043	14.5310.02.053	14.5310.02.033	
Back check function, speed control, HO	4	14.5310.02.044	14.5310.02.054	14.5310.02.034	

Door Closers, Slide Arm Channel



d line offers a slide arm channel option for doors where projecting arm closers are not suitable or acceptable. In addition there is an intelligently engineered and specially integrated closer system available for pairs of rebated doors. In the channel operated closer option, minimalism is yet again achieved and easily integrates with the design qualities of other d line products.



Standard Specification:
Conform to EN1154/EN1634

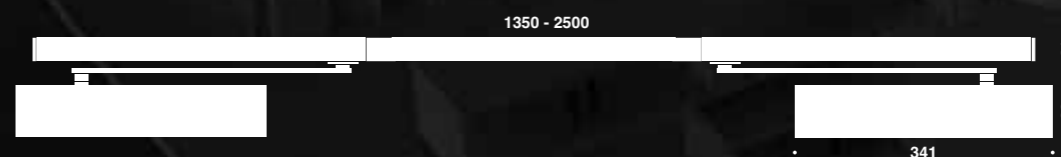

■ Single Leaf

	EN Size	Pull and Push Side	Door Size Max. Width	Door Size Max. Weight
Back check function, latch action, hold open device	2-5	14.5306.02.000	1100	100



■ Double Leaf, Integrated Door Selector

	EN Size	Pull Side	Push Side	Door Size Max. Width	Door Size Max. Weight
Back check, delayed closure, latch action, speed closure	2-5	14.5393.02.030		1350-2500	120
Back check, delayed closure, latch action, speed closure 1 magnet hold open	2-5	14.5393.02.035		1350-2500	120
Back check, delayed closure, latch action, speed closure 2 magnet hold open	2-5	14.5393.02.040		1350-2500	120

Panic Exit Devices

The design homogeneity of the **d line** Total Solution also includes panic exit devices. Although an item of standardised appearance, Knud Holscher has managed to place his distinctive **d line** 'mark' upon it. One reason being that the covers on the panic exit devices are drawn from the same model as the door closers; i.e. both have tight bends. In this way, a visually appealing sense of coherence and continuity is maintained. **d line's** design idiom emerges intact.

x = available to special order

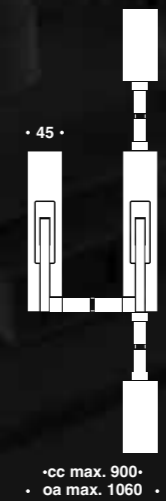
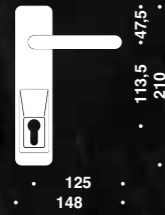

Standard Specification:
Conform to EN1125

		Fixed Measure Cutttable cross bar to match: 900mm	Variable Measure Cutttable cross bar to match: max. 900mm
Single panic latch	Wood/metal glass	14.5120.02.900 x	x x
Single panic bolt	Wood/metal glass	14.5122.02.925 x	x x
External access attachment	Wood/metal glass	14.5103.02.002 x	x x
Single panic latch for mortice lock	Wood/metal	14.5125.02.900	x

Lock Cases



d line lock cases are manufactured to operate smoothly with d line levers. The lock cases use exceptionally strong return springs and stainless steel forends and strikes. In addition to their anti-corrosive properties the forends and strike plates require little maintenance.

Thus it is the superior quality of the materials, coupled with innovative engineering and high manufacturing standards that make the d line range of ironmongery durable and reliable.

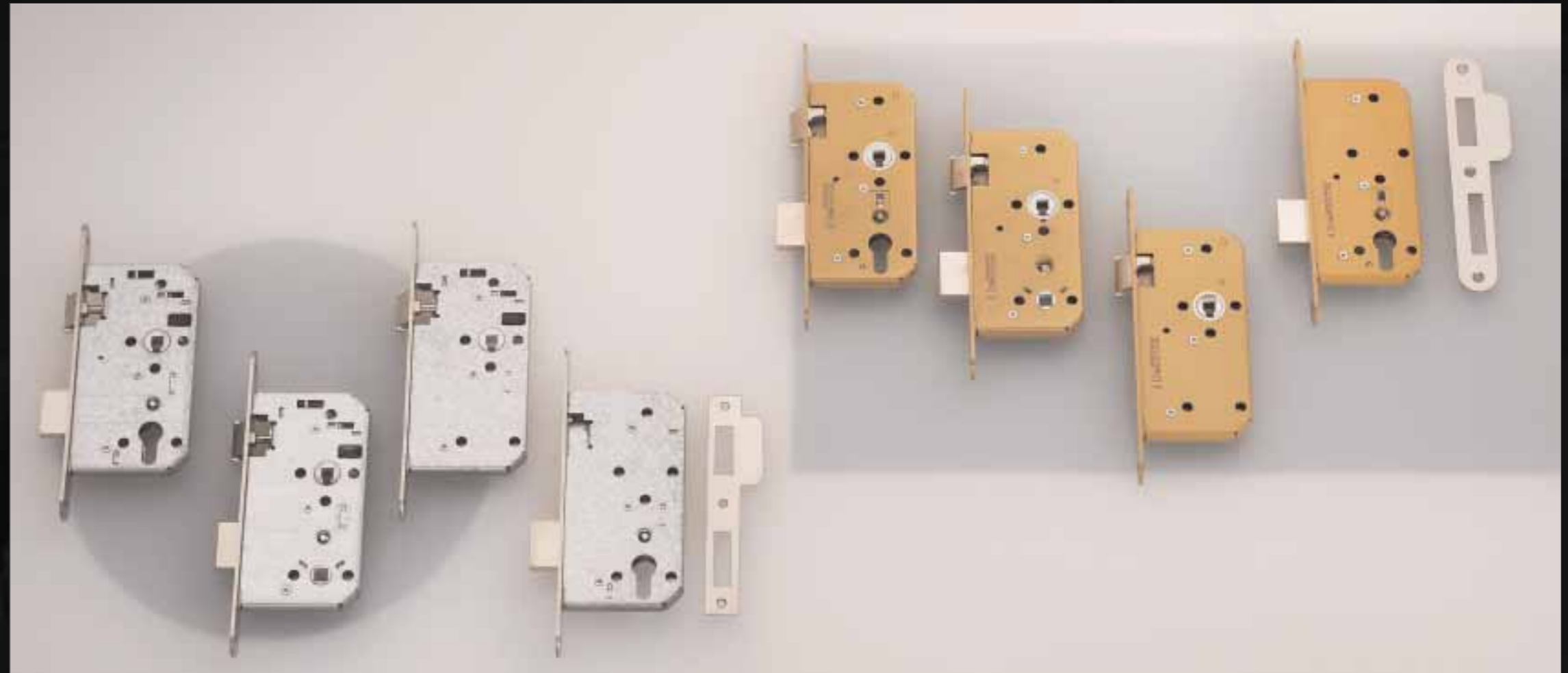

Standard Specification:
 Conform to DIN 18251/EN12209
 Complete with striking plate, screws and template

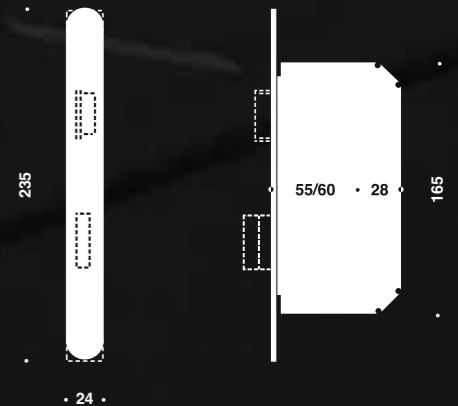

• 24 •

	■ Reversible					■ Handed RH							
	Sash Lock	Bathroom Lock	Bathroom Dead Lock	Latch Lock	Dead Lock	Sash Lock Right	Left	WC Lock Right	Left	Bathroom Lock Right	Left	Dead Lock Right	Left
'Heavy duty'	Radiused forend	Backset 55				14.9000.02.559	14.9000.02.558	14.9002.02.559	14.9002.02.558	14.9004.02.559	14.9004.02.558	14.9006.02.559	14.9006.02.558
	Square forend	Backset 60	14.9011.02.600	14.9013.02.600	14.9015.02.600	14.9017.02.600	14.9001.02.559	14.9001.02.558	14.9003.02.558	14.9003.02.558	14.9005.02.559	14.9005.02.558	14.9007.02.559
'Extra heavy duty'	Radiused forend	Backset 55				14.9030.02.559	14.9030.02.558	14.9032.02.559	14.9032.02.558	14.9034.02.559	14.9034.02.558	14.9036.02.559	14.9036.02.558
	Square forend	Backset 60	14.9010.02.600	14.9012.02.600	14.9018.02.600	14.9014.02.600	14.9016.02.600	14.9030.02.609	14.9030.02.608	14.9032.02.609	14.9032.02.608	14.9034.02.609	14.9034.02.608
		Backset 55				14.9031.02.559	14.9031.02.558	14.9033.02.559	14.9033.02.558	14.9035.02.559	14.9035.02.558	14.9037.02.559	14.9037.02.558
		Backset 60				14.9031.02.609	14.9031.02.608	14.9033.02.609	14.9033.02.608	14.9035.02.609	14.9035.02.608	14.9037.02.609	14.9037.02.608

Locks and Cylinders



Supplementing the range of lock cases for standard timber doors, d line offers a complete range of special locks manufactured to meet special demands. Especially developed for narrow doors and fire doors, these lock cases live up to the high standards set by d line where durability, strength, and functional reliability are concerned.

The d line range of cylinders, supplementary to the standard line of products are manufactured by EVVA, the international market leader. Manufacture is to high technical standards and European norms.

Standard Specification:
Patented
Conform to DIN 18251/18250/EN1303

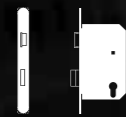
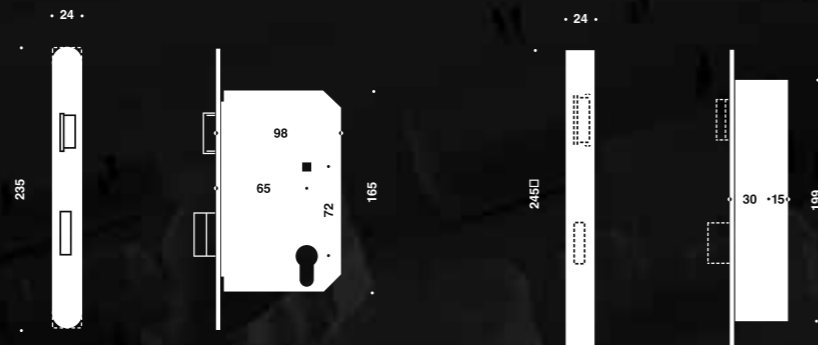

Right Left

■ Panic Lock RH/LH	Right	Left
Rounded forend, backset 65mm	14.9050.02.659	14.9050.02.658
Square forend, backset 65mm	14.9051.02.658	14.9051.02.658

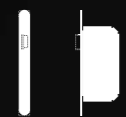

Right Left



With Auxiliary Latch
Right Left

■ Night Latch RH/LH	Right	Left	With Auxiliary Latch Right	Left
Rounded forend, backset 60mm	14.9038.02.609	14.9038.02.608	14.9042.02.609	14.9042.02.608
Square forend, backset 60mm	14.9039.02.609	14.9039.02.608	14.9043.02.609	14.9043.02.608



Entrance Lock



Latch Lock

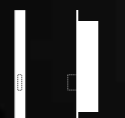

Dead Bolt Lock



Roller Bolt Lock



Hook Lock

■ Narrow Style Sash Lock RH/LH	Right	Left	Right	Left	Right
Square forend, backset 30mm	14.9061.02.300	14.9065.02.300	14.9067.02.300	14.9069.02.300	14.9063.02.300
Strike plate	14.9090.02.501	14.9090.02.210	14.9090.02.111	14.9090.02.401	14.9090.02.900

d line has a special department for in-house production of lock cylinders and keys.

The design and manufacture of lock systems requires a detailed knowledge of the elements involved and the proper principles for safeguarding valuables.

With its wide range of cylinders, d line sets a new standard in the field of lock systems.

With the advent of d line's in-house lock production, it was pertinent to concurrently establish a special department of experts in co-operation with regional d line consultants that now guarantee a consistently competent advisory capacity for contractors, architects and other relevant parties.

d line offers MK (Master Key), GMK (Grand Master Key) and

GGMK (Great Grand Master Key) lock systems, as well as the delivery of d line cylinders in KA (Key Alike) and KD (Key Differ).

Dependent upon the required level of security, d line offers a variety of system types:

- DPS - Double Profile System
- DPS-V - Double Profile System Vario
- 3KS-V - 3 Curve System
- 3KS - 3 Curve System Vario
- MCS - Magnetic Code System

As well, all of the above-mentioned systems are available with euro motor cylinders.

d line guarantees that all information pertaining to either a planned or ongoing building project will remain completely inaccessible to unauthorized persons. As we base our

integrity as independent advisors and suppliers on the trust of our partners, mutual discretion is a prerequisite for all of our services.

d line cylinders offer a variety of advantages:

- Patented and EN1303-certified lock systems (DPS, 3KS and MCS systems)
- Quick delivery
- Technologically adapted solutions
- User-friendliness
- Well-planned delivery of system components
- Clear and concise mounting instructions



Single



Double



Twin Cylinder with Turn

■ Cylinders	Single	Double	Twin Cylinder with Turn
Please specify length of cylinder	14.DPS0.00.	14.DPS0.20.	14.DPS0.40.
Regarding locking systems please ask your local d line contact			



Documentation photos in
Hardware from following locations:

Rockwool	Café Sommersko
Energie	Esprit
French Connection	GUBI
Mads Norgaard	Peak Performance

Project: Swiss Re
Architect: Forster and Partners
Credits: View, Nick Guttridge

Hardware
Bathroom
Washroom
Handrail
Wardrobe
Signs